

Styleline® **PROFILE**

**DOE 2017
COMPLIANT
& REGISTERED**



Installation Manual

STYLELINE®
GLASS DOOR SYSTEMS

052024

Table of Contents:

Parts & Tools Needed for Installation..... 2

Digital Materials Available On-line..... 3

Locate the Model & Serial Number..... 3

Net Cooler Opening (NCO) Chart..... 4

Unpack the Frames.....5

LED Lighting Occupancy & Anti-sweat Sensor Installation6

Set Frames into Net Cooler Opening (NCO)..... 7-8

Unpack the Doors..... 9

Install Doors into Frame(s)..... 10-11

Adjust Door Alignment 11

4 Door Shelving Assembly 12

Notes..... 12

Warranty..... 13



BEFORE YOU BEGIN:

Read these instructions completely and carefully.

FOR YOUR SAFETY:

Read and observe all CAUTIONS and WARNINGS shown throughout these instructions.



This warning does not mean that STYLELINE® products will cause cancer or reproductive harm, or is in violation of any product-safety standards or requirements. As clarified by the California State government, Proposition 65 can be considered more of a 'right to know' law than a pure product safety law.

When used as designed, STYLELINE® believes that our products are not harmful. We provide the Proposition 65 warning to stay in compliance with California State law. It is your responsibility to provide accurate Proposition 65 warning labels to your customers when necessary. For more information on Proposition 65, please visit the California State government website.



CAUTION:

Risk of injury. While performing installations described, gloves and safety goggles should be worn.



WARNING:

Risk of electrical shock. Disconnect power before servicing or installing product. Switch the power off at the service panel and follow appropriate lock out/tag out safety procedures.

Parts & Tools Needed for Installation:

Tools Supplied:

- Mounting screws
- Shims
- Silicone Tube



Tools Required:

- Tape measure
- Screwdriver: Phillips No. 2
- Hammer
- Crow bar
- Clamps
- Scissors/razor blade
- Ladder
- Level



Digital Materials Available On-line:

Download this manual and other informative materials from our website. QR-Code is also located in product label.

Scan QR Code

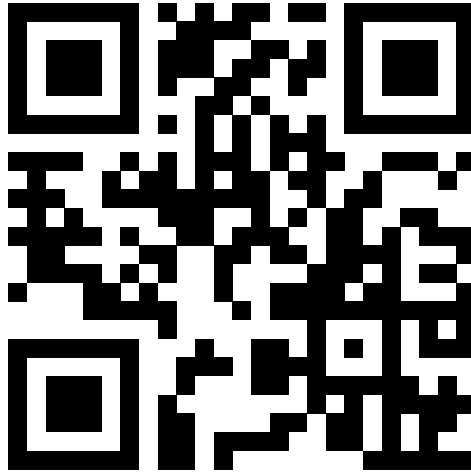

1- Locate the Model & Serial Number:

The model and serial number are located on the packing list, on the product label (**Figure 1**) or on the first left side frame facing the cooler. The model number consists of a combination of numbers and letters. Example: 041A-PNAALE7-APBLRLR.

The label also includes electrical data and QR Code.



by Commercial Refrigerator Door Company

THIS DOOR IS DESIGNED AND CERTIFIED FOR USE IN WALK IN COOLER APPLICATIONS

DATE OF MFG:

MODEL: 041A-PNAALE7-APBLRLR **HEATERS AMPS:** 0.59 **EC:** 3.26 kWh/DAY

SERIAL: 0058868-1-1-2 **LIGHTS AMPS:** 0.40 **120 VAC / 60Hz**

DESCRIPTION: 04-Door STYLELINE® CL (NT) G2 FRAME ONLY - **FINISH:** SMOOTH SATIN SILVER

LIGHTING: LED - **ENDLIGHT:** DOUBLE - **INLAY:** NONE - **HINGE:** LEFT - **LOCKS:** NO

Commercial Refrigerator Door | 6200 Porter Road, Sarasota FL 34240 | 800.237.3940 | 941.377.2850 - fax | www.styleline.com



Intertek

CONFORMS TO
UL471 & NSF 2
CERTIFIED TO CSA
C22.2#120



Intertek
4005070

Figure 1

2- Net Cooler Opening (NCO) Chart:

Door Size WxH	24" X 75"	30" X 75"
NCO Height	75"	75"

Door Lineup	Net Cooler Opening Width	
2	4'-0 7/8"	5'-2 1/4"
3	6'-0 5/8"	7'-8 11/16"
4	8'-0 3/8"	10'-3 1/8"
5	10'-0 1/8"	12'-10 11/16"
6	12'-1"	15'-5 1/8"
7	14'-0 3/4"	17'-11 9/16"
8	16'-0 1/2"	20'-6"
9	18'-1 3/8"	23'-1 5/8"
10	20'-1 1/8"	25'-8 1/16"
11	22'-0 7/8"	28'-2 1/2"
12	24'-0 5/8"	30'-8 15/16"
13	26'-1 1/2"	33'-4 1/2"
14	28'-1 1/4"	35'-10 15/16"
15	30'-1"	38'-5 3/8"
16	32'-0 3/4"	40'-11 13/16"
17	34'-1 11/16"	43'-7 3/8"
18	36'-1 7/16"	46'-1 13/16"
19	38'-1 3/16"	48'-8 1/4"
20	40'-0 15/16"	51'-2 11/16"

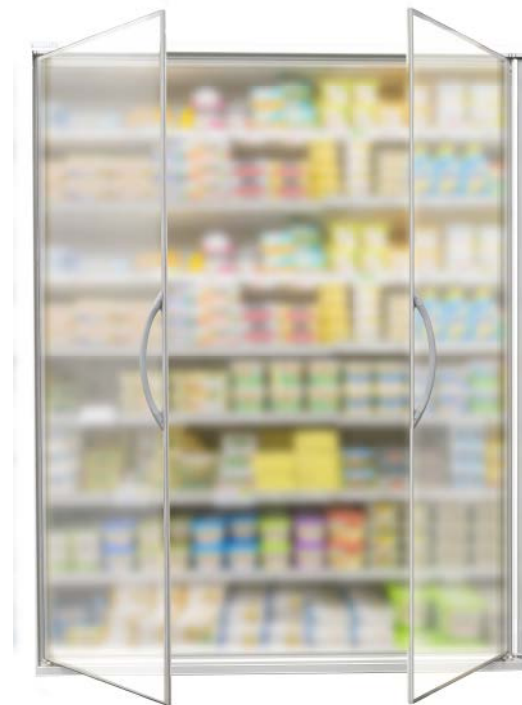

Styleline® **PROFILE**

3- Unpack the Frames:

3.1 Remove all wood from both sides of the frame package. Frames are shipped as "single and double side" crates (**Figure 2**).

3.2 Each line-up includes a set of tools listed on page 2, and an installation manual. Remove, and save for later use.

3.3 Remove the screws holding the frame(s) into the crate(s).

3.4 Remove the frame(s) from the crate(s). The frames should be removed from the side of the crate without corner braces. Safely set aside in the upright position.

3.5 Remove the stretch wrap holding the LED lights to the mullion (**Figure 3**).



Figure 2



CAUTION:

Risk of product damage. Be careful not to damage LED lights.



CAUTION:

Risk of product damage. Do not unpack doors until frames are installed.



Figure 3

4- LED Lighting Occupancy & Anti-Sweat Control Sensor Installation:

4.1 Lay frame flat on floor, facing up.

4.2 Locate and remove occupancy or anti-sweat sensor kit packaging from the top of the frame. **(Figure 4).**

4.3 Remove foil tape from the frame to expose occupancy sensor wiring. **(Figure 5).**

4.4 Locate RJ45 cable and 4-prong terminal connections on frame.

4.5 Attach bracket to the frame. **(Figure 6).**

4.6 Attach occupancy sensor to the occupancy sensor bracket using (3) provided screws. **(Figure 7).**

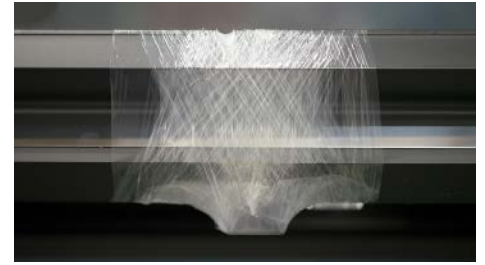

Figure 4



Figure 5



Figure 6



Figure 7



LED Occupancy & Anti-sweat Sensor Kit. Supplied with Normal Temp Doors. White for Silver Frames. Black for Black Frames.



Anti-sweat Sensors & LED Motion Sensor Installed



LED Occupancy Sensor & Anti-sweat Sensor Connected

5- Set Frames Into Net Cooler Opening (NCO):

NOTE: Confirm that NCO will accommodate the frames to be installed by checking dimensions. (Figure 8).

NOTE: Frames are numbered on a green label located at the top left corner on the inside of the frame.



CAUTION:

Risk of product damage. The frame(s) are not designed to support any weight from the walk-in box. Make any necessary box modifications to ensure the frames slide easily into the opening.

5.1 Set frame #1 at the left end of the opening. Clamp to wall to prevent the frame from falling out of the opening (Figure 9). Make sure the frame is pushed all the way in.



IMPORTANT:

If installing multiple frames, make sure to use "J" trim as shown on Figure 10.

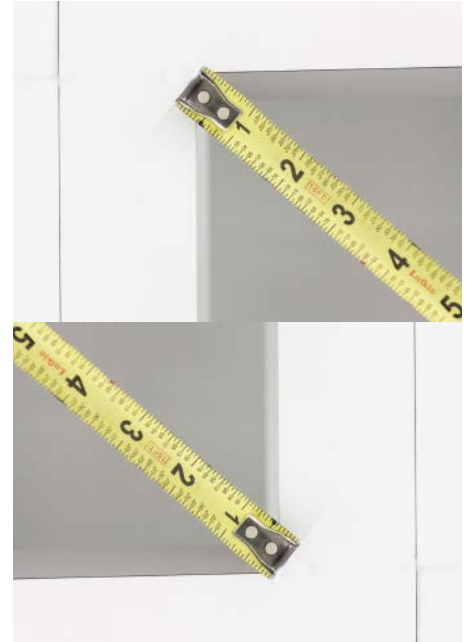

Figure 8



Figure 9

5- Set Frames into the Net Cooler Opening (NCO): - Cont'd

5.2 Set frame #2 next to frame #1. Clamp in place. (Figure 9).

5.3 Install "J" (joint trim) between frames. If pre-drilled holes do not match, new holes may need to be drilled. Fasten screw binding male to female. (Figure 10).

Ensure that all top flanges are level. Ensure that the frame and flange are plumb to the surface of the cooler all around the NCO.

5.4 Repeat steps for all remaining frames.

5.5 Center the lineup (left to right) in the opening. Make sure the lineup is square by measuring diagonals on one of the frames – within 1/8".

5.6 Install all bottom mounting screws - **do not tighten**. If there is any gap at any bottom mounting screw, install shims. Tighten all screws.

5.7 Reconfirm the diagonal measurements (Figure 11).

5.8 Install all side mounting screws - **do not tighten**. If there is any gap at any mounting screw, install shims. In addition, it is especially important to shim the top two corners of the frame lineup to prevent the top of the frame from shifting left or right. Tighten all screws. Reconfirm diagonal measurements and adjust mounting screws and shims accordingly (Figure 12).

5.9 Install all top mounting screws - **do not tighten**. If there is any gap at any mounting screw, install shims. Tighten all screws.

5.10 Tighten all sex bolt screws. (Figure 10).

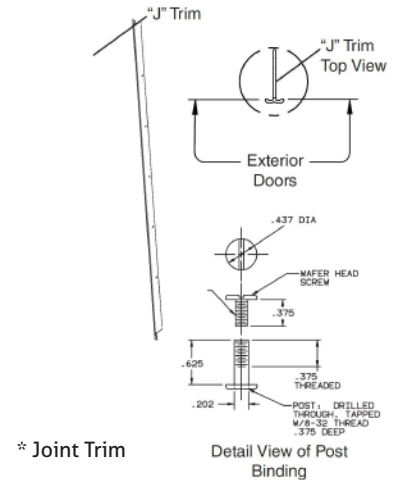

Figure 10

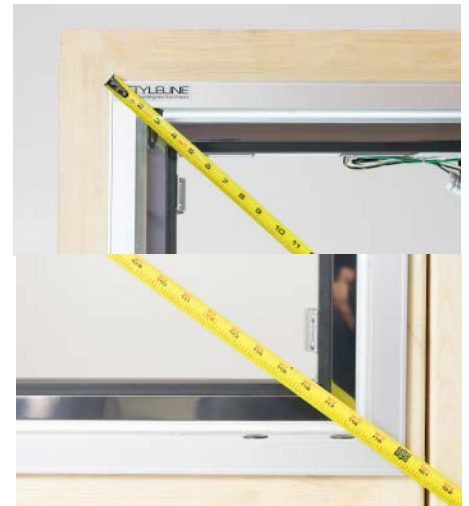

Figure 11



CAUTION:

Risk of product damage. Do not over-tighten mounting screws. Over-tightening of screws may cause distortion and/or twisting of the frame.

5.11 Trim off all excess shim stock. (Figure 13).

IMPORTANT: Fill all gaps with silicone caulk between the back of the frames and the buck opening. This includes the back side of the frame joint behind the seam jacket.



Figure 13

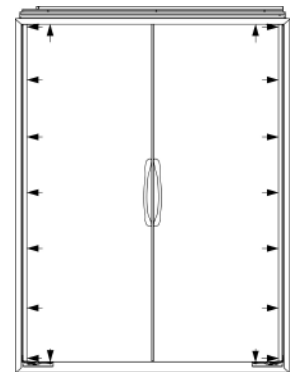

Frame-to-Cooler Fastener Locations - Figure 12

6- Unpack the Doors:

- 6.1 Remove the plastic stretch wrap from the door packs (**Figure 14**).
- 6.2 Remove the two wood boards at the top.
- 6.3 Cut the steel band on ONE END ONLY and remove the end of the crate.
- 6.4 Cut the center band and remove the wood board from the top.
- 6.5 Fold the cardboard back over the remaining band.
- 6.6 Remove one door at a time from the package.
- 6.7 Remove any protective plastic wrap from the door(s) and set them aside for later installation.



Figure 14



CAUTION:

Risk of product damage. Do NOT remove the remaining end band; all the doors will fall if the remaining band is cut.

Risk of product damage. Do not lift doors by the handle.

7- Install Doors into Frame(s):

7.1 Remove bottom hinge plate shoulder screw before installing door. **Re-insert screw after applying tension to hinge. (Figures 15)**.

7.2 Install all the doors left to right. (Left and right side doors are crated separately.) **Never lift doors by the handle during installation.**

7.3 Locate top of frame pin. **(Figure 16).**

7.4 Lift the door up onto the top hinge pin. To do this, Angle the door slightly. The bushing in the door should easily slide onto the top hinge pin **(Figure 17).**

7.5 Set the bottom of the door into the hinge plate hole. **(Figure 18).**

7.6 Torque the door using a ½ in. open-end wrench. Turning wrench toward door handle adds tension. 6 to 8 "clicks". Do not apply tension to doors with bottom hinge plate shoulder screw installed. **(Figures 19 - 19A).**



Figure 15 - A



Figure 15 - B



Figure 16



Figure 17



Figure 18



CAUTION:
Risk of product damage. Do not apply tension to doors with bottom hinge plate shoulder screw installed.



CAUTION:
Risk of product damage. Do not lift doors by the handle.



CAUTION:
Risk of product damage. Do not over-torque door — no more than 8 "clicks."



Figure 19



Figure 19 - A

7- Install Doors into Frame(s) - Cont'd:

7.7 To remove torque from door, lift door directly out of the hinge plate. Do not attempt to remove torque by turning the wrench in the opposite direction. (Figure 20).



Figure 20



CAUTION:

Risk of product damage. Do not attempt to remove torque by turning the wrench in the opposite direction.

8- Adjust Door Alignment:

NOTE: After all the doors are installed, some doors may need to be adjusted for good fit and finish. Effort to open door handle should not exceed 25 lbs. maximum force.

8.1 Use door alignment correction guideline image as reference. (Figures 21).

Bottom hinge adjustments

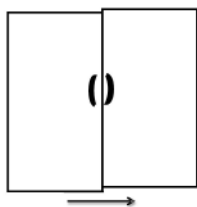

Figure 21



CAUTION:

Risk of product damage. If the door torsion rod is over torqued, damage to the hinge plate or door torsion rod may result.



To Correct Shift the Bottom Plate to the Right

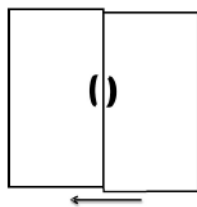

To Correct Shift the Bottom Plate to the Left

Door Alignment Correction Guideline - Figure 21



STYLELINE® warrants its products against defects in workmanship and materials for a period of 2 years from date of shipment. STYLELINE LED Plus light strip and Power Supply are warranted against defects in workmanship and materials for 5 years. In addition, Commercial Refrigerator Door Company warrants its insulating glass against condensation between lites of glass for a period of 10 years for unheated glass.

Under this warranty, Commercial Refrigerator Door Company's liability is specifically limited to repairing or replacing, F.O.B. Commercial Refrigerator Door Company's factory, at our option, any part of the product determined by Commercial Refrigerator Door Company to be not in conformance with this warranty. This warranty does not include any on-site repair or replacement costs.

The customer service department will provide written authorization to either return or field-scrap the defective part. Upon receipt of the defective part, warranty status will be verified and an appropriate credit issued.

This warranty shall not apply to any product which is repaired or altered without our acknowledgment and consent, operated or installed contrary to our instructions, subjected to misuse or improper maintenance, damaged by accident or negligence, or not paid for in full.

This warranty is extended to the original purchaser and is in lieu of all other warranties, expressed or implied, including but not limited to warranties of merchantability or fitness for a particular use.

THERE ARE NO WARRANTIES OTHER THAN THAT DESCRIBED HEREIN AND NO REPRESENTATIVE OF Commercial Refrigerator Door Company HAS AUTHORITY TO ALTER THIS WARRANTY.



062022DOE

6200 Porter Road, Sarasota FL 34240 | 800.237.3940 | www.styleline.com | sales@styleline.com